

REFERENCE FILE COPY SERVICE INFORMATION FROM HEWLETT-PACKARD
PLEASE DO NOT REMOVE

March/April 1986

Battery Charging With a Hewlett-Packard Power Supply

Introduction

The charging and discharging of batteries has become an area of careful study in the aerospace and automotive industries as well as many others. Precise control of both the charging and discharging characteristics of batteries may be necessary in applications ranging from satellite design to battery development and evaluation.

Although sufficient for many consumer applications, the comparatively poor charging control of readily available battery chargers may not provide the precision necessary in many critical applications. To achieve a high degree of accuracy, stability and regulation, the dc power supply approach can be utilized. This same power supply, with little or no modification, can also be used for controlled battery discharging.

Two different types of battery charging techniques using Hewlett-Packard dc power supplies will be explained in this article. For information on precise control of battery discharging using a power supply, order HP Application Note 250-2 from one of the addresses on the back page of this issue of *Bench Briefs*. The connection diagrams illustrated here are typical. To ensure proper operation use the exact connections as illustrated in the operating and service manual for the power supply being used. If the power supply and components are carefully chosen the results should be more than satisfactory.

Charge Methods

One of the most common approaches to charging batteries is the "constant current" method sometimes referred to as a "slow charge." As the name implies, it typically requires 14-16 hours to fully charge a nickel-cadmium cell. The charge rate for this method is typically 0.1C, where C is the nominal ampere-hour rating of the cell. At this charge rate standard Ni-Cad sealed cells can tolerate an overcharge for extended periods of time without damage or serious performance degradation.

The other charging method we will discuss is the "taper charge" method. When charging lead-acid cells, many manufacturers recommend that the charging current be reduced as the charge nears completion. This "taper charge" can be accomplished by inserting a small resistance in series with one of the load leads between the power supply and the battery being charged.

Constant Current Charging

The automatic crossover between constant voltage and constant current exhibited by most Hewlett-Packard power supplies make them ideal for battery charging applications. Using this feature, a battery may be charged at a constant current until the maximum charge voltage is reached, at which point the supply will revert to constant voltage and continue to supply a trickle charge current sufficient to maintain full charge (see Figure 1). Thus, after connecting the

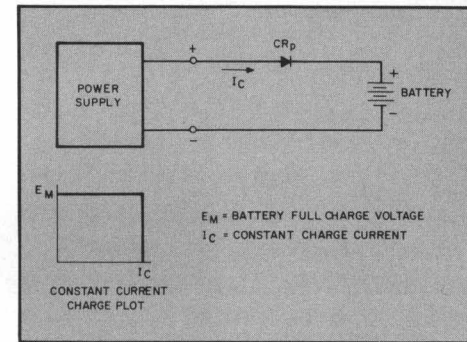

Figure 1. Constant Current Charging

battery to the power supply and setting the proper charging rate, the charging operation can be left unattended.

Constant Current Charging Procedure

The procedure for setting the charging rate and full charge voltage on constant voltage/constant current power supplies is as follows:

1. Turn both the VOLTAGE and CURRENT controls fully counterclockwise (CCW).
2. Place a short circuit across the output terminals of the supply and rotate the VOLTAGE control fully clockwise (CW).
3. Rotate the CURRENT control to the desired charging rate as read on the front panel ammeter.
4. Rotate the VOLTAGE control fully CCW and remove the short circuit.
5. Rotate the VOLTAGE control to the desired full charge voltage as read on either the front panel

voltmeter or a more precise DVM. Remember to set the voltage 0.7 volts more than the required full charge voltage to compensate for the drop across diode CRp. The unit may then be connected to the battery terminals (positive to positive and negative to negative).

Taper Charging

Taper charging means that the charge current is gradually reduced as the

battery nears completion of its charge. The resistor Rt accounts for the taper charge. The value of this resistance is the difference between the full charge voltage (Em) and the voltage at which the tapering is to start (Et), divided by the maximum charging current (Ic). The current charging plot and the connection diagram for taper charging are shown in Figure 2. Follow the same procedure for taper charging as for constant current charging. □

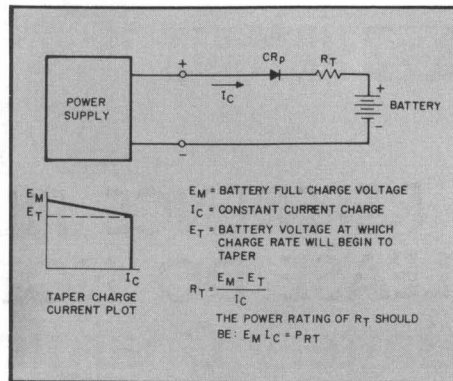

Figure 2. Taper Charging.

Troubleshooting Tip

Finding Short Circuits on Printed Circuit Boards

Measure Minute Current Differences with an HP 3466A Multimeter or Simple Microvolt Meter Circuit

*Ike Ogilvie,
HP San Diego Div.*

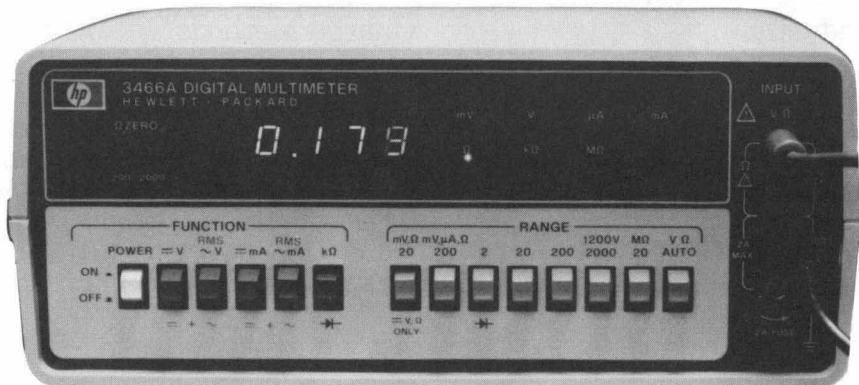

HP3466A

One of the hardest faults to find on a printed circuit board covered with a lot of integrated circuits is the short circuit. One simple method that I have found very successful, even on multi-layer boards, involves using a microvolt meter, such as the HP 3466A Digital Multimeter, an ordinary 1.5 volt flashlight battery and a 150 ohm current limiting resistor. If a microvolt multimeter with the same specifications as the HP 3466A Digital Multimeter (1 uVdc sensitivity) is not available, refer to Figure 1, which is a schematic of a simple microvolt meter circuit that can be constructed very economically.

The troubleshooting procedure for a typical short circuit is shown in Figures 2 and 3. The fault is a shorted bypass capacitor between the 5 volt supply and common at point "D." To isolate this short, connect the positive side of the battery to the 5 volt bus and the negative side with the 150 ohm resistor in series to the common bus. In observing the voltage readings the actual values

are not important, it is only necessary to note whether the readings are getting larger or smaller to determine in which direction the current is flowing.

As shown in Figure 2, we will use the negative meter probe to make five voltage readings; the positive meter probe is connected to point "A." The first reading is made at point "B." Note the small voltage reading. Make the second voltage reading with the negative meter probe at point "F." This voltage reading should be the same or slightly less than the previous voltage reading. This second reading shows that the current drawn by the short circuit is not flowing in the circuit from point "B" to point "F." Make the third voltage reading with the negative meter probe at point "C." This third reading will be larger than the two previous readings. Make the fourth voltage reading at point "D." This fourth reading will also be larger than the previous readings. Make the fifth voltage reading at point "E." This fifth reading will be the

same or slightly less than the voltage reading at point "D."

This fifth reading shows that the current drawn by the short circuit is not flowing in the circuit from point "D" to point "E." Close examination of the circuit layout on the board will show that there are no other paths for the current except through point "D." By assuming that point "D" (where we noted the highest reading) is the short circuit, we assume that the bypass capacitor is shorted.

To prove that the bypass capacitor is shorted, refer to Figure 3. Connect the battery with the 150 ohm resistor in series across the bypass capacitor and connect the positive meter probe

Correction

The HP 3065H service class scheduled on July 7, 1986 (see January/February 1986 BB) has been moved back two weeks. The new dates are July 21 - Aug. 1.

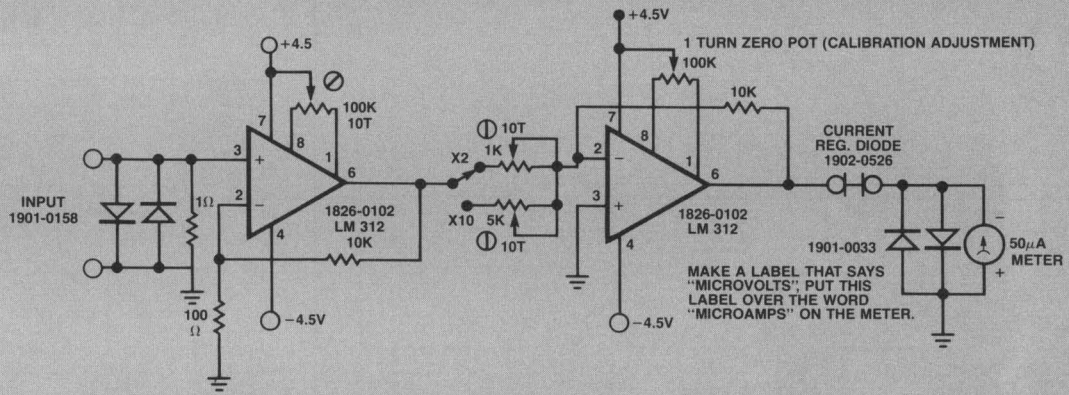
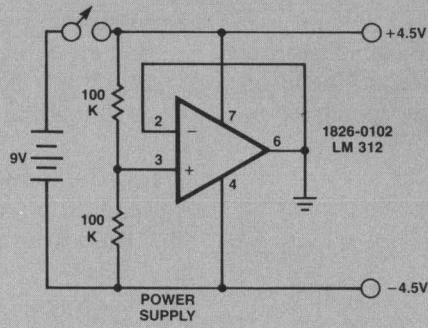

Figure 1. Simple dual range microvolt meter circuit with power supply.

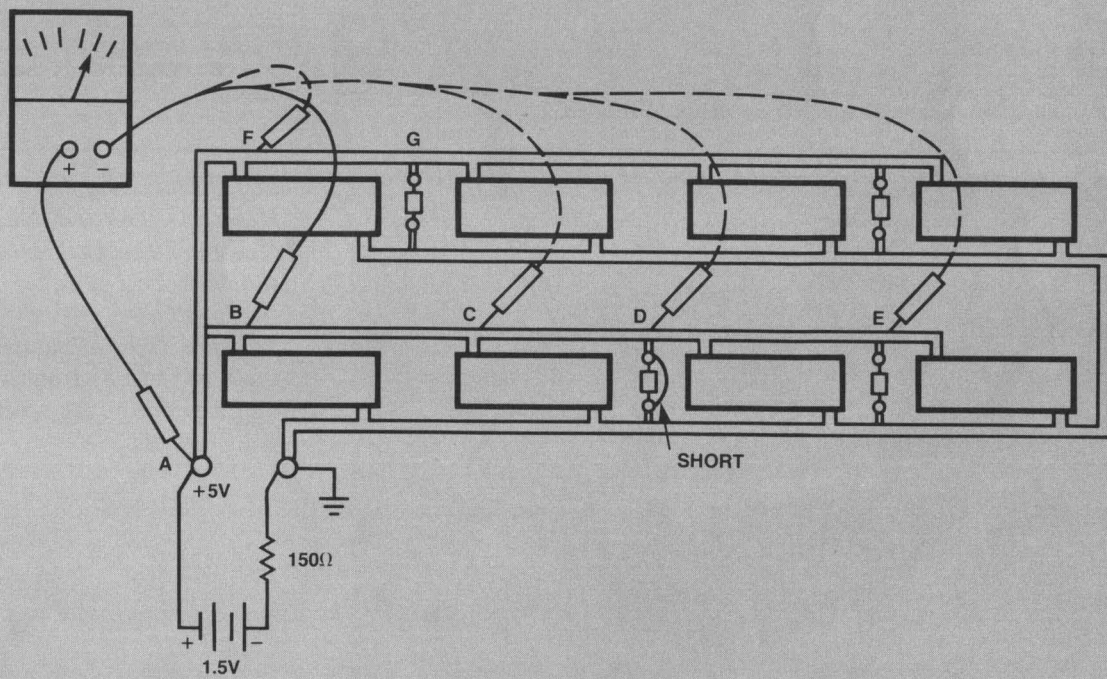

Figure 2. Series of readings to find shorted bypass capacitor at point "D."

to point "D." Make the first voltage reading by connecting the negative meter probe to point "C." This reading should be almost zero volts. Make the second voltage reading by connecting the negative meter probe to point "E." This reading should be almost zero volts. These last two voltage readings show that no current

is flowing in the circuit away from point "D." All of the current is flowing through the shorted bypass capacitor.

Using this method of troubleshooting, I have measured a voltage drop on a printed circuit trace as short as an eighth of an inch.

Another good use of this method is to troubleshoot a low or missing signal at the output of an IC. For example, there is an abnormally low signal at point "b" (refer to Figure 4). Is IC A's output low, or is IC B, C, or D loading the output of IC A?

With the power on, measure the voltage drop from point "a" to point "b," then from point "a" to point "c," and finally from point "a" to point "d." The largest voltage would indicate which IC is loading down the output of IC A. If there is very little or no voltage drops, this would indicate that IC A has a low output. □

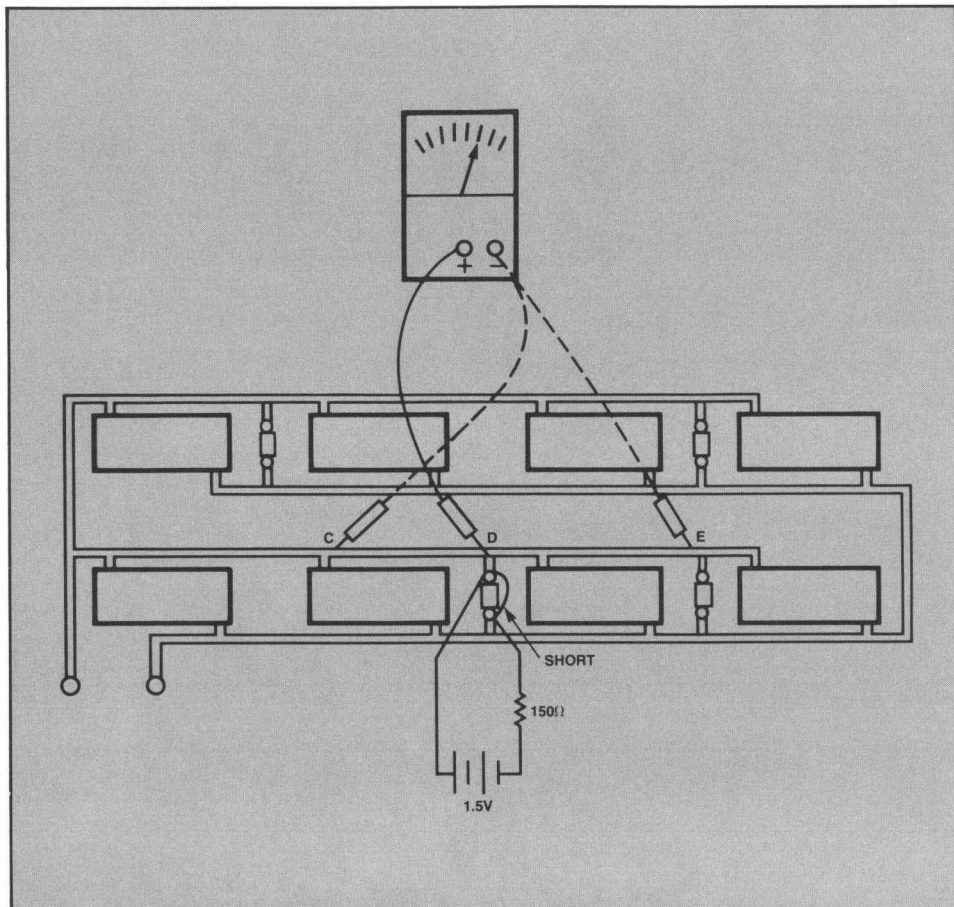

Figure 3. Series of readings to determine that the capacitor is shorted.

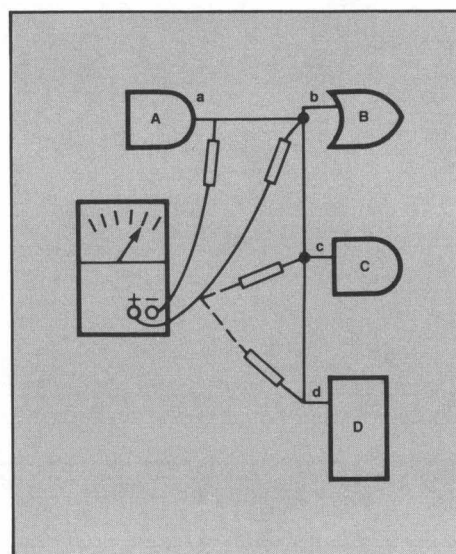
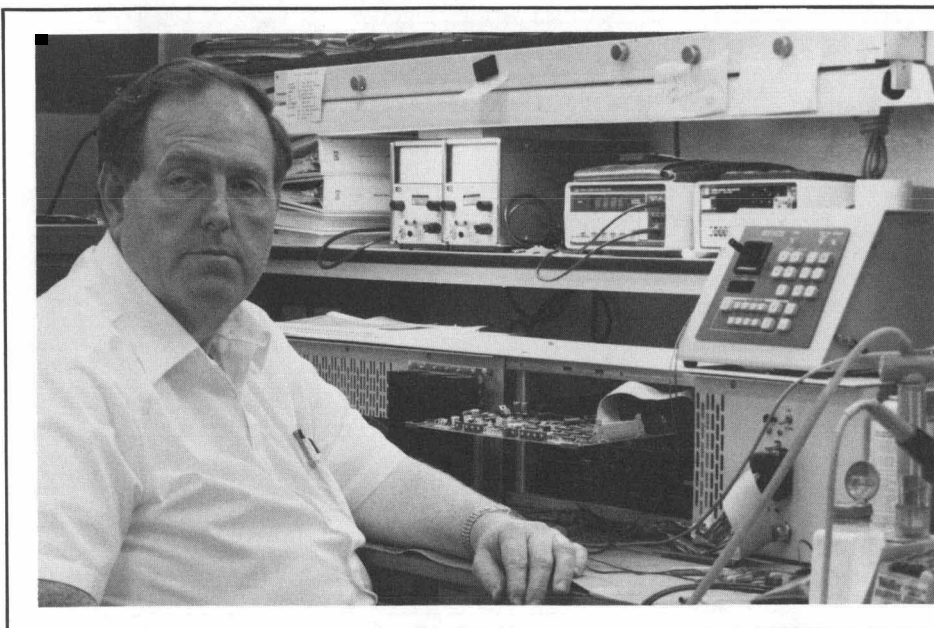

Figure 4. Determining if "A's" output is low or if "B," "C," or "D" is loading "A's" output.



Ike Ogilvie has been with the Hewlett-Packard San Diego Division 20 years as an electronic technician. Ike's current responsibilities with the graphics plotters board repair group include testing, troubleshooting and repairing line products and field returns.

Announcing HP Ten-Year Minimum Support:

A Further Definition of Lasting Value

Lasting value is an integral part of every HP product. Lasting value means enduring quality in both hardware and software as well as in strategies to protect these investments. It also means support and service to help you get the most out of the products and systems throughout their useful lives.

Now Hewlett-Packard has extended its support commitment to a minimum of ten years after active manufacture of the product*. This

commitment includes the availability of parts, maintenance services, training, usage assistance, and a whole host of other programs designed to ensure you access to the help you need in using your HP products effectively.

What's more, this backup is only a minimum. In many special situations, we will continue to offer support beyond this time period. This continuing effort is an extension of our larger commitment to an ongoing

partnership. We stand behind our products with support you can count on—for the long run.

**A partial list of products covered by this program appears in the Support Program flyer, HP P/N 5954-2830. New products will be added to the program periodically. Contact your HP sales office for the most current information.*

HP Support is Full Range as Well as Long Term

Hewlett-Packard provides support services during the active production of all HP products. Now, for the products on the ten-year program, Hewlett-Packard provides trained professionals to deliver quality support for at least ten years after product discontinuance.

This support includes hardware maintenance services and software support services at various levels to meet your needs. Standard

agreements offering flexibility in response time and coverage hours provide a cost-effective alternative to per-incident support at published rates. These support services are delivered through centralized Response Centers and local support offices throughout the world.

In addition, you can obtain training and consulting services to help you make the most productive use of your

HP solution and prolong the value of your investment in time as well as money.

You can purchase all of the above services during the active production of the products as well as during the ten year minimum support life which begins after product discontinuance. They are part of an entire support program dedicated to maximizing the value of your HP solution.

supplement to **BENCH BRIEFS** SERVICE NOTE INDEX

Need Any Service Notes?

They're free!

Here's the latest listing of service notes. They recommend modifications to Hewlett-Packard instruments to

increase reliability, improve performance, or extend their usefulness.

Use the form at the rear of *Bench Briefs* to order, free of charge, service notes for several instruments.

If you would like to purchase large quantities of service notes covering a wide range of instruments, or if you desire a complete history of all service notes documenting all changes to your instruments, Hewlett-Packard offers a microfiche library for a one time charge. There is also a microfiche subscription service available that automatically updates the library on a quarterly schedule.

The part numbers for the service note microfiche library and subscription service are:

Library— 5951-6511
Subscription service— 5951-6517

Contact your local HP Sales Office for ordering information.

HP 1332A/1333A X-Y DISPLAYS WITH MEDICAL OPTION 333, 563 OR C52

1332A-17. Serials 2252A19570 and below. Smoke-gray CRT filters may be wrong type.
1333A-10. All serials. Smoke-gray CRT filters may be wrong type.

HP 1335A X-Y DISPLAY

1335A-17A. Serials 2517A and below. Modification to prevent persistence failure (flood gun illumination in all modes).

HP 1335A X-Y DISPLAY WITH MEDICAL OPTION 333, 563, C20 OR C23

1335A-18. Serials 2515A15236 and below. Smoke-gray CRT filters may be wrong type.

HP 1336A X-Y DISPLAY

1336A-2A. All serials. ARC Protection Kit for circuit protection.

HP 1336S X-Y DISPLAY

1336A-3A. Serials 1809A and below. Modification to increase the range of the intensity limit adjustment.

HP 1349A/D DIGITAL DISPLAY

1349A/D-1. 1349A serials 2437A00201 and below; 1349D serials 2437A00919 and below. Modification to prevent HV transient arc.

HP 1630A/D/G LOGIC ANALYZER

1630A/D/G-7. 1630A Serial prefix 2401A to 2515A; 1630D serial prefix 2401A to 2514A; 1630G serial prefix 2510A and below. Modification to protect trace on power supply board.
1630A/D-8. 1630A all serials; 1630D all serials. Firmware change from tape based mass storage to disc based mass storage and timing post processing.

HP 1631A/D LOGIC ANALYZER

1631A/D-3. 1631A serials 2509A and below; 1631D serials 2510A and below. PROM replacement to correct firmware.
1631A-4. Serials 2525A and below. PROM replacement to correct firmware. Supersedes 1631A/D-2.
1631A/D-5. 1631A and 1631D all serials. Clarification on using probe compensation with the 1631A/D.
1631A/D-6. 1631A serials 2525A and below; 1631D serials 2518A and below. Lost timing display in mixed mode.
1631A/D-7. 1631A serials 2540A and below; 1631D serials 2518A and below. Modification to protect trace on power supply board.
1631A/D-8. 1631A serials 2428A and below; 1631D serials 2424A and below. Modification to the power supply primary current limit circuit to improve performance.

HP 3054A DATA ACQUISITION AND CONTROL UNIT

3054A-3. Serial numbers: All revision A units. Modification to the HP 3054A LOGGER program.

HP 3055S PC BASED DATA ACQUISITION SYSTEM

3055S-1. All serials. Modification to the 3055S UTILITY program.

HP 3065 BOARD TEST SYSTEM

3065-39. 3065H serials 2310A00518 and below. Modification to correct mis-wiring in test station terminal power cable for systems with power options 220 or 240.

HP 3312A FUNCTION GENERATOR

3312A-5. Serials 1432A13975 and below. New gold plated connectors for the A1 and A2 boards.

HP 3325A SYNTHESIZER/FUNCTION GENERATOR

3325A-20. Serials 2512A20063 and below. List of new PC board connectors and cables.

HP 3326A TWO-CHANNEL SYNTHESIZER

3326A-4. Serials 2437A00460 and below. Power supply modifications to improve performance.

HP 3336C (OPT 005) LEVEL GENERATOR

3336C-17. Serials 1932A00794 through 2504A04544. "On Carrier Return Loss" test failures may be due to cables.

HP 3421A DATA ACQUISITION AND CONTROL UNIT

3421A-13. Serials 2338A04275 and below. Improved case for the HP 3421A.

HP 3457A DIGITAL MULTIMETER

3457A-2. Serials 2505A00710 and below. Enhancing the digital board to improve performance.
3457A-3. Updated performance tests.

HP 3466A DIGITAL MULTIMETER

3466A-15. Serial prefix 2549 and above and serial prefix 1716 and below. System II cabinets inch/metric conversion.

HP 3497A DATA ACQUISITION AND CONTROL UNIT

3497A-24. Serials: voltmeter boards (03497-66505) of Revision C or greater. Modification to the zero offset adjustment procedure.

HP 3577A NETWORK ANALYZER

3577A-4A. Serials 2333A10908 and below. Masked ROMS replace EPROMS.
3577A-5A. Serials 2333A11392 and below. New 5 volt connector.
3577A-8. All serials. Modification to improve performance and prevent confidence test #6 failure.

HP 3586A/B/C SELECTIVE LEVEL METER

3586A/B/C-11. Serials 1927A00798 to 2509A01285; 1928A01179 to 2510A03710; 1929A00553 to 2511A01637. Faulty diode keeps fan on in standby.

HP 3702B IF/BB RECEIVER

3702B-52. All serials. Preferred replacement for transistor A4Q7.

HP 3705A DIFFERENTIAL PHASE DETECTOR

3705A-8. All serials. Calibration frequency on Option 015 instruments.

HP 3708A NOISE AND INTERFERENCE TEST SET

3708A-0. Service note index.
3708A-5. All serials. Clarification of power meter linearity specification.

HP 3711A IF/BB TRANSMITTER

3711A-5. Serials 2450U00583 and below. Improving the ALC performance/swept level flatness.

HP 3712A IF/BB RECEIVER

3712A-12. All serials. Preferred replacement for transistor A4Q1.
3712A-13. Serials between 2444U00594 and 2444U00694. Modification to improve mounting of decoupling capacitor.

HP 3717A 70MHz MODULATOR-DEMODULATOR

3717A-5. Serials 2512U00665 and below. Modification to protect transformer T1 secondary terminals.

HP 3762A DATA GENERATOR

3762A-9. Serials 2543U01221 and below. Modification to overvoltage protection circuit to improve performance.

HP 3763A ERROR DETECTOR

3763A-7C. Serials 2150U00800 and below. Preferred replacement for A141C27 (1820-1755), A141C26 (1820-2040) and 03763-60114 (timer assembly).
3763A-13. Serials 2545U01186 and below. Modification to overvoltage protection circuit to improve performance.

HP 3764A DIGITAL TRANSMISSION ANALYZER

3764A-0. Service note index.
3764A-14. Serials 2528U00857 and below. Clock oscillator retrofit kit for the 3764A Std., Option 002 or Option 003.
3764A-15. Serials 2528U00827 and below. Modification to prevent intermittent "SL" flag display.

HP 3770B TELEPHONE LINE ANALYZER

3770B-0. Service note index.

HP 3771A/B DATA LINE ANALYZER

3771A/B-0. Service note index.

HP 3776A/B PCM TERMINAL TEST SET (Option 001)

3776A-0. Service note index.
3776A-18B. Serials 2444U00292 and below. Frequency update instructions for data measurement Option 001.
3776A-23A. All serials. 3776 test programs data cartridge (HP P/N 03776-10001) modifications-update to Revision D.
3776A-25. All serials. Preferred replacement of RAM HP P/N 1818-1614.
3776B-0. Service note index.
3776B-22A. Serials 2437U00742 and below. Modification to improve measurement accuracies in time-slot 24.
3776B-24B. All serials. 3776 test programs data cartridge (HP P/N 03776-10001) modifications-update to Revision D.
3776B-26. All serials. Preferred replacement of RAM HP P/N 1818-1614.
3776B-27. Serial numbers 2437U00642 and above. Retrofit instructions for adding Option H01 (quantization distortion noise measurement) to the 3776B.

HP 3777A CHANNEL SELECTOR

3777A-0. Service note index.

HP 3779A PRIMARY MULTIPLEX ANALYZER

3779A-37. All serials. Preferred replacement for assemblies A23, A24, A25 and A26.
3779A-38. All serials. Instructions for retrofitting the HP 3779C/D A1 assembly to the HP 3779A.
3779A-40. All serials. Instructions for retrofitting the HP 3779C/D A9 assembly to the HP 3779A.
3779A-41. All serials. Instructions for retrofitting the HP 3779C/D A16 assembly to the HP 3779A.
3779A-44. All serials. Instructions for retrofitting the HP 3779C/D A21 assembly to the HP 3779A.
3779A-46. All serials. Instructions for retrofitting the HP 3779C/D A35 assembly to the HP 3779A.
3779A-48. Serials 00225 and below. Preferred replacement for IC U65 on the A16 assembly.
3779A-49. All serials. Procedures to add complex impedance termination on analog ports.
3779A-50. Serials 2003U and below. Modification to improve repeatability on A-A/D-A measurements.
3779A-51. Serials 00225 and below. Modification to improve adjustment range of the synthesizer clock frequency.
3779A-52. Serials 00225 and below. Modification to improve adjustment range of digital transmitter clock frequency.
3779A-53. Serials 00205 and below. Modification to prevent operator failure code R27 on A-D type measurements.
3779A-55. All serials. Recommended replacement for IC U11 on the A13 assembly.
3779A-56. All serials. Modification to prevent possible HP-IB problems when using the HP 2225A ThinkJet printer.

HP 3779B PRIMARY MULTIPLEX ANALYZER

3779B-40. All serials. Preferred replacement for assemblies A23, A24, A25 and A26.
3779B-41. All serials. Instructions for retrofitting the HP 3779C/D A1 assembly to the HP 3779B.
3779B-43. All serials. Instructions for retrofitting the HP 3779C/D A9 assembly to the HP 3779B.
3779B-44. All serials. Instructions for retrofitting the HP 3779C/D A16 assembly to the HP 3779B.

- 3779B-47. All serials. Instruction for retrofitting the HP 3779C/D A21 assembly to the HP 3779B.
- 3779B-51. Serials 00300 and below. Preferred replacement for IC U66 on the A16 assembly.
- 3779B-52. All serials. Procedures to add complex impedance termination on analog ports.
- 3779B-53. Serials 2015U and below. Modification to improve repeatability on A-A/D-A measurements.
- 3779B-54. Serials 00300 and below. Modification to improve adjustment range of the synthesizer clock frequency.
- 3779B-55. Serials 00300 and below. Modification to improve adjustment range of digital transmitter clock frequency.
- 3779B-56. Serials 2015U and below. Modification to prevent failure codes S163 or S242 on digital self-test 4.
- 3779B-57. Serials 00255 and below. Modification to prevent operator failure code R27 on A-D type measurements.
- 3779B-58. Serials 00275 and below. Modification to improve power supply reliability.
- 3779B-59. All serials. Recommended replacement for IC U11 on the A13 assembly.
- 3779B-60. All serials. Modification to prevent possible HP-IB problems when using the HP 2225A ThinkJet printer.

HP 3779C PRIMARY MULTIPLEX ANALYZER

- 3779C-0. Service note index.
- 3779C-23. Serials 00459 to 00508. Modification to the A26 assembly to prevent possible corruption of NVM data.
- 3779C-26. All serial numbers. Procedures to add complex impedance termination on analog ports.
- 3779C-27. Serials 00404 and below. Modification to the A29 assembly for heat protection from R10 resistor.
- 3779C-28. All serials. Modification to prevent possible HP-IB problems when using the HP 2225A ThinkJet printer.

HP 3779D PRIMARY MULTIPLEX ANALYZER

- 3779D-0. Service note index.
- 3779D-30. All serials. Procedures to add complex impedance termination on analog ports.
- 3779D-32. Serials 00334 and below. Modification to the A29 assembly for heat protection from R10 resistor.
- 3779D-33. All serials. Modification to prevent possible HP-IB problems when using the HP 2225A ThinkJet printer.

HP 3780A PATTERN GENERATOR/ERROR DETECTOR

- 3780A-0. Service note index.

HP 3781A/B PATTERN GENERATOR

- 3781A-0. Service note index.
- 3781B-0. Service note index.

HP 3782A/B ERROR DETECTOR

- 3782A-0. Service note index.
- 3782B-0. Service note index.

HP 3785A/B JITTER GENERATOR & RECEIVER

- 3785A-0. Service note index.
- 3785A-17. All serials. Preferred replacement for A39 assembly.
- 3785B-0. Service note index.
- 3785B-15. All serials. Preferred replacement for A39 assembly.

HP 3791B BB TRANSMITTER PLUG-IN

- 3791B-0. All serials. Service note index.

HP 3793B DIFFERENTIAL PHASE DETECTOR

- 3793B-0. All serials. Service note index.
- 3793B-3A. All serials. Factory retrofit procedure for Options 201, 211, 212 and 221.
- 3793B-6. All serials. Modification to improve calibration frequency on Option 015 instruments.

HP 4935A TRANSMISSION IMPAIRMENT MEASURING SET

- 4935A-14. Recommended replacement parts to improve performance.

HP 4936A TRANSMISSION IMPAIRMENT TEST SET

- 4936A-3. Serials 2326U01320 and below. Modification to improve performance and prevent fuse blowing on the power supply.

HP 4937A TRANSMISSION IMPAIRMENT TEST SET

- 4937A-2A. Serials 2523A and below. Modifications to the loop-start and noise-to-ground circuits.

HP 4945A TRANSMISSION IMPAIRMENT SET

- 4945A-6. Serials between 2435A00500 and 2521A00800. Recommended replacement parts to improve performance.

HP 5180A WAVEFORM RECORDER

- 5180A-22. All serials. Procedure to improve tracking loop adjustment results.

HP 5340A FREQUENCY COUNTER

- 5340A-17A. All serials. Instructions to perform Quad Detector adjustment when replacing A1 Preamplifier Assemblies.
- 5340A-18A. All serials. Adjustment procedures to perform when replacing the A2 Preamplifier Assemblies.
- 5340A-21B. All serials. Option 006 microwave limiter retrofit instructions.

HP 5342A MICROWAVE FREQUENCY COUNTER

- 5342A-35A. All serials. HP 5342A front panel replacement kit HP P/N 05342-60204.
- 5342A-44. Serials 2508A and above. Correcting amplitude Option 002 display jitter by modifying the A27 assembly.
- 5342A-45. All serials. Improving the phase noise output when a 5344S is connected to an HP 8350A Sweep Oscillator.
- 5342A-46. All serials. Precautions in using IC part number 1DD8-0502 in the A3 assembly.

HP 5343A MICROWAVE FREQUENCY COUNTER

- 5343A-22. All serials. Improving the phase noise output when a 5344S is connected to an HP 8350A Sweep Oscillator.
- 5343A-23. All serials. Improved troubleshooting procedure for A17 PRS generator assembly.
- 5343A-24. All serials. Precautions in using IC part number 1DD8-0502 in the A3 assembly.

HP 5344S SOURCE SYNCHRONIZER

- 5344S-2. All serials. Improving the phase noise output when a 5344S is connected to an HP 8350A Sweep Oscillator.

HP 5350A MICROWAVE FREQUENCY COUNTER

- 5350A-1. Serials 2444A00158 and below. Modification to A6 IF amp/detector board for overload indicator.

HP 5351A MICROWAVE FREQUENCY COUNTER

- 5351A-1. Serials 2444A00125 and below. Modification to A6 IF amp/detector board for overload indicator.

HP 8513A TEST SET

- 8513A-2A. All serials. Port 1 and 2 center conductor and outer nut replacement.

HP 8515A TEST SET

- 8515A-2A. All serials. Port 1 and 2 center conductor and outer nut replacement.

HP 8552B SPECTRUM ANALYZER IF SECTION

- 8552B-14A. All serials. Modification to improve 10 Hz operation.

HP 10342B/C BUS PREPROCESSOR

- 10342B/C-1. All serials. Service policy clarifications.

HP 10780A MEASUREMENT RECEIVER

- 10780A-3. Serials 2204A13322 and below. Modification to prevent J1 connector rotation.

HP 37201A HP-IB EXTENDER

- 37201A-0. All serials. Service note index.
- 37201A-6A. Option 050. Modification to improve reliability of U329 voltage supply.

HP 37203A HP-IB EXTENDER

- 37203A-0. All serials. Service note index.
- 37203A-10. All serials. Notification of take control asynchronous problem.

HP 37212A MODEM

- 37212A-0. All serials. Service note index.

HP 37214A SYSTEMS MODEM CARD CAGE

- 37214A-0. All serials. Service note index.

HP 54100A/D DIGITIZING OSCILLOSCOPES

- 54100A/D-1. 54100A all serials; 54100D all serials. Timebase board incompatibility with CPU board.

HP 54200A/D DIGITIZING OSCILLOSCOPES

- 54200A/D-2. 54200A serials 2511A and below; 54200D serials 2513A and below. Power supply change requires new cooling fan.

HP 59309A HP-IB DIGITAL CLOCK

- 59309A-8. Serials 2510A03976 to 2510A04075. Modification to prevent reset of time display when switching to dc power.

HP 64110A DEVELOPMENT STATION

- 64110A-10. Serials 2450A01280 through 2519A01406. Incorrect resistor network value on CPU/IO board.

HP 64206S 6301V/6303R EMULATOR POD

- 64206A-1. Serials 2519J00101 through 2519J00155 (inclusive). Modification to output port signals in background operation.
- 64206A-2. Serials 2519J00156 through 2519J00199 (inclusive). Modification to output port signals in background operation.

HP 64253A Z80 EMULATOR SUBSYSTEM

- 64253A-1. Serials 2507A, CPU board 64253-66502 or 69502. Firmware change to OP CODE tracker circuit.

HP 64671A 6809/6809E INTERFACE MODULE

- 64671A-1. Serials 2350A and below. Modification to eliminate invalid status and erratic J clocking.

Service Note Order Form

If you want service notes, please check the appropriate boxes below and return this form separately to one of the following addresses.

Hewlett-Packard
1820 Embarcadero Road
Palo Alto, California 94303

For European customers (ONLY)

Hewlett-Packard
Nederland BV
Central Mailing Dept.
P.O.Box 529
1180 AM Amstelveen
The Netherlands

Name _____
Firm _____
Address _____
City _____
State _____ Zip _____

- | | | | | | |
|--------------------------------------|---------------------------------------|------------------------------------|-----------------------------------|------------------------------------|-------------------------------------|
| <input type="checkbox"/> 1332A-17 | <input type="checkbox"/> 3466A-15 | <input type="checkbox"/> 3776A-25 | <input type="checkbox"/> 3779B-47 | <input type="checkbox"/> 3785A-0 | <input type="checkbox"/> 5351A-1 |
| <input type="checkbox"/> 1333A-10 | <input type="checkbox"/> 3497A-24 | <input type="checkbox"/> 3776B-0 | <input type="checkbox"/> 3779B-51 | <input type="checkbox"/> 3785A-17 | <input type="checkbox"/> 8513A-2A |
| <input type="checkbox"/> 1335A-17A | <input type="checkbox"/> 3577A-4A | <input type="checkbox"/> 3776B-22A | <input type="checkbox"/> 3779B-52 | <input type="checkbox"/> 3785B-0 | <input type="checkbox"/> 8515A-2A |
| <input type="checkbox"/> 1335A-18 | <input type="checkbox"/> 3577A-5A | <input type="checkbox"/> 3776B-24B | <input type="checkbox"/> 3779B-53 | <input type="checkbox"/> 3785B-15 | <input type="checkbox"/> 8552B-14A |
| <input type="checkbox"/> 1336A-2A | <input type="checkbox"/> 3577A-8 | <input type="checkbox"/> 3776B-26 | <input type="checkbox"/> 3779B-54 | <input type="checkbox"/> 3791B-0 | <input type="checkbox"/> 10342B/C-1 |
| <input type="checkbox"/> 1336A-3A | <input type="checkbox"/> 3586A/B/C-11 | <input type="checkbox"/> 3776B-27 | <input type="checkbox"/> 3779B-55 | <input type="checkbox"/> 3793B-0 | <input type="checkbox"/> 10780A-3 |
| <input type="checkbox"/> 1349A/D-1 | <input type="checkbox"/> 3702B-52 | <input type="checkbox"/> 3777A-0 | <input type="checkbox"/> 3779B-56 | <input type="checkbox"/> 3793B-3A | <input type="checkbox"/> 37201A-0 |
| <input type="checkbox"/> 1630A/D/G-7 | <input type="checkbox"/> 3705A-8 | <input type="checkbox"/> 3779A-37 | <input type="checkbox"/> 3779B-57 | <input type="checkbox"/> 3793B-6 | <input type="checkbox"/> 37201A-6A |
| <input type="checkbox"/> 1630A/D-8 | <input type="checkbox"/> 3708A-0 | <input type="checkbox"/> 3779A-38 | <input type="checkbox"/> 3779B-58 | <input type="checkbox"/> 4935A-14 | <input type="checkbox"/> 37203A-0 |
| <input type="checkbox"/> 1631A/D-3 | <input type="checkbox"/> 3708A-5 | <input type="checkbox"/> 3779A-40 | <input type="checkbox"/> 3779B-59 | <input type="checkbox"/> 4936A-3 | <input type="checkbox"/> 37203A-10 |
| <input type="checkbox"/> 1631A-4 | <input type="checkbox"/> 3711A-5 | <input type="checkbox"/> 3779A-41 | <input type="checkbox"/> 3779B-60 | <input type="checkbox"/> 4937A-2A | <input type="checkbox"/> 37212A-0 |
| <input type="checkbox"/> 1631A/D-5 | <input type="checkbox"/> 3712A-12 | <input type="checkbox"/> 3779A-44 | <input type="checkbox"/> 3779C-0 | <input type="checkbox"/> 4945A-6 | <input type="checkbox"/> 37214A-0 |
| <input type="checkbox"/> 1631A/D-6 | <input type="checkbox"/> 3712A-13 | <input type="checkbox"/> 3779A-46 | <input type="checkbox"/> 3779C-23 | <input type="checkbox"/> 5180A-22 | <input type="checkbox"/> 54100A/D-1 |
| <input type="checkbox"/> 1631A/D-7 | <input type="checkbox"/> 3717A-5 | <input type="checkbox"/> 3779A-48 | <input type="checkbox"/> 3779C-26 | <input type="checkbox"/> 5340A-17A | <input type="checkbox"/> 54200A/D-2 |
| <input type="checkbox"/> 1631A/D-8 | <input type="checkbox"/> 3762A-9 | <input type="checkbox"/> 3779A-49 | <input type="checkbox"/> 3779C-27 | <input type="checkbox"/> 5340A-18A | <input type="checkbox"/> 59309A-8 |
| <input type="checkbox"/> 3054A-3 | <input type="checkbox"/> 3763A-7C | <input type="checkbox"/> 3779A-50 | <input type="checkbox"/> 3779C-28 | <input type="checkbox"/> 5340A-21B | <input type="checkbox"/> 64110A-10 |
| <input type="checkbox"/> 3055S-1 | <input type="checkbox"/> 3763A-13 | <input type="checkbox"/> 3779A-51 | <input type="checkbox"/> 3779D-0 | <input type="checkbox"/> 5342A-35A | <input type="checkbox"/> 64206A-1 |
| <input type="checkbox"/> 3065-39 | <input type="checkbox"/> 3764A-0 | <input type="checkbox"/> 3779A-52 | <input type="checkbox"/> 3779D-30 | <input type="checkbox"/> 5342A-44 | <input type="checkbox"/> 64206A-2 |
| <input type="checkbox"/> 3312A-5 | <input type="checkbox"/> 3764A-14 | <input type="checkbox"/> 3779A-53 | <input type="checkbox"/> 3779D-32 | <input type="checkbox"/> 5342A-45 | <input type="checkbox"/> 64253A-1 |
| <input type="checkbox"/> 3325A-20 | <input type="checkbox"/> 3764A-15 | <input type="checkbox"/> 3779A-55 | <input type="checkbox"/> 3779D-33 | <input type="checkbox"/> 5342A-46 | <input type="checkbox"/> 64671A-1 |
| <input type="checkbox"/> 3326A-4 | <input type="checkbox"/> 3770B-0 | <input type="checkbox"/> 3779A-56 | <input type="checkbox"/> 3780A-0 | <input type="checkbox"/> 5343A-22 | |
| <input type="checkbox"/> 3336C-17 | <input type="checkbox"/> 3771A/B-0 | <input type="checkbox"/> 3779B-40 | <input type="checkbox"/> 3781A-0 | <input type="checkbox"/> 5343A-23 | |
| <input type="checkbox"/> 3421A-13 | <input type="checkbox"/> 3776A-0 | <input type="checkbox"/> 3779B-41 | <input type="checkbox"/> 3781B-0 | <input type="checkbox"/> 5343A-24 | |
| <input type="checkbox"/> 3457A-2 | <input type="checkbox"/> 3776A-18B | <input type="checkbox"/> 3779B-43 | <input type="checkbox"/> 3782A-0 | <input type="checkbox"/> 5344S-2 | |
| <input type="checkbox"/> 3457A-3 | <input type="checkbox"/> 3776A-23A | <input type="checkbox"/> 3779B-44 | <input type="checkbox"/> 3782B-0 | <input type="checkbox"/> 5350A-1 | |

Please photocopy this order form if you do not want to cut off the page.

Hewlett-Packard (Canada) Ltd.
6877 Goreway Drive
Mississauga, Ontario L4V 1M8

BENCH BRIEFS
MARCH/APRIL 1986
Volume 26 Number 2

Service information from
Hewlett-Packard Company

To obtain a qualification form for a free subscription, send your request to the above address.

Reader comments or technical article contributions are welcomed.

Please send them to the
Bench Briefs Editor.

Editor: Jim Bechtold
Hewlett-Packard

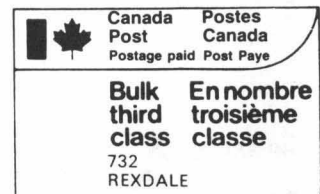

All rights reserved. Permission to reprint Bench Briefs granted upon written request to the Editor.

Printed in U.S.A.